

① Starting Position

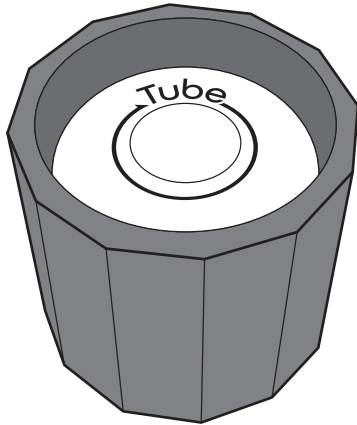

The silver piece inside can move up and down.

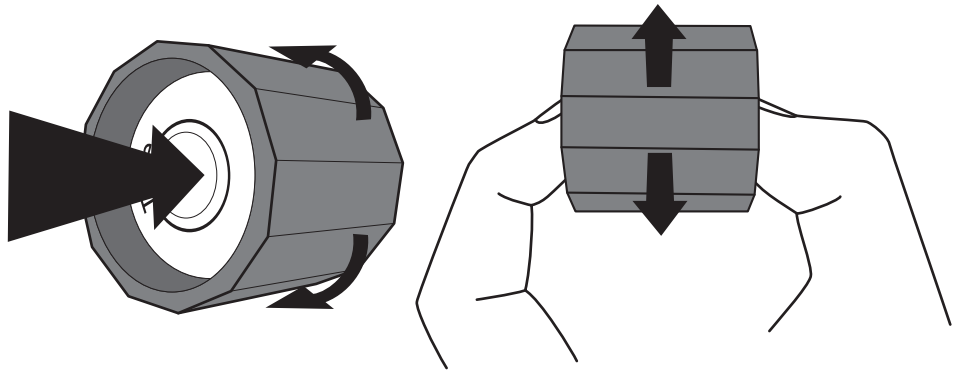

When it doesn't move, hold the inner piece lightly with your finger as shown in the figure, and rotate the outer piece so that the inner piece can move up and down.

② Place it on a flat surface and rotate it vigorously.

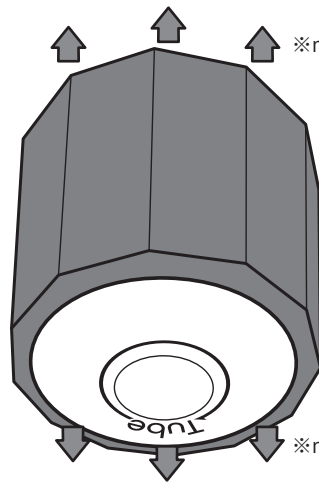
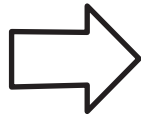
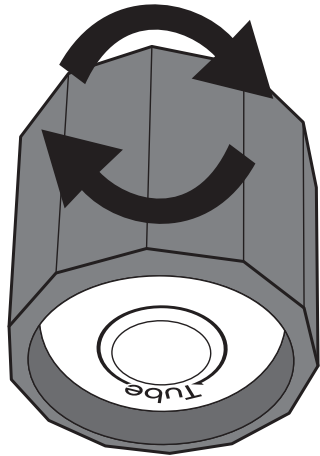

※move outward due to centrifugal force

Rotate to move the inner piece outward as shown. Rotate until both sides move outward.

※move outward due to centrifugal force

③ Rotate in the direction of the arrow on a flat surface.

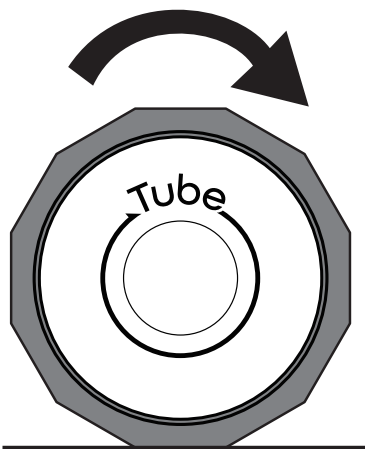

When you rotate it, the inner pieces will gradually come out from both sides.

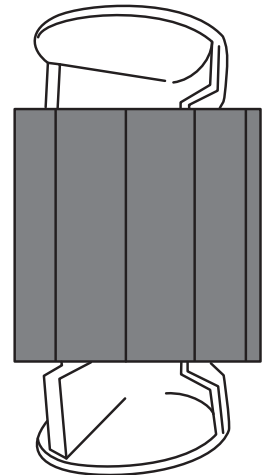
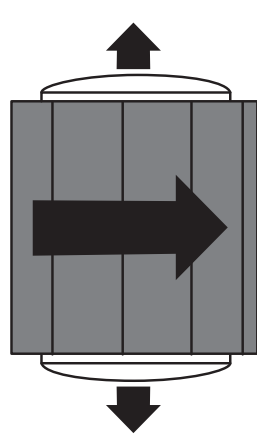

The pieces come apart.

To reassemble, rotate the outer piece while lightly pushing in the inner piece from both sides.